

1:7
STÖDSTORP

FHK 2021-05-07

A	SE PM1	STLÖ	2020-05-XX
BET	ÄNDRINGEN AVSER	SIGN	DATUM

BYGGLOVSHANDLING

VAGGERYD LOGISTIKPARK
VAGGERYD



ORIENTERINGSGIFUR

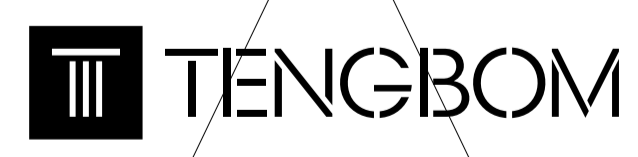

UPPDRAG NR 1036147	RITAD AV S Löf	HANDLÄGGARE S Löf
DATUM 2021-03-15	ANSVARIG A Drackner	

NYBYGGNAD AV LOGISTIKANLÄGGNING
STÖDSTORP 1:7
Situationplan

SKALA 1:500 (A1) 1:1000 (A3)	NUMMER A-01-1-001	BET A
------------------------------------	----------------------	----------

FÖRKLARINGAR / FÖRESKRIFTER

Alla plushöjder är preliminära och avser ÖK betongbjälklag.

- ▼ Entré
- ▼ Lastport
- - - Brandcellsgräns EI60
- - - Brandcellsgräns EI30
- AK Armbågskontakt
- U Utrymningsväg

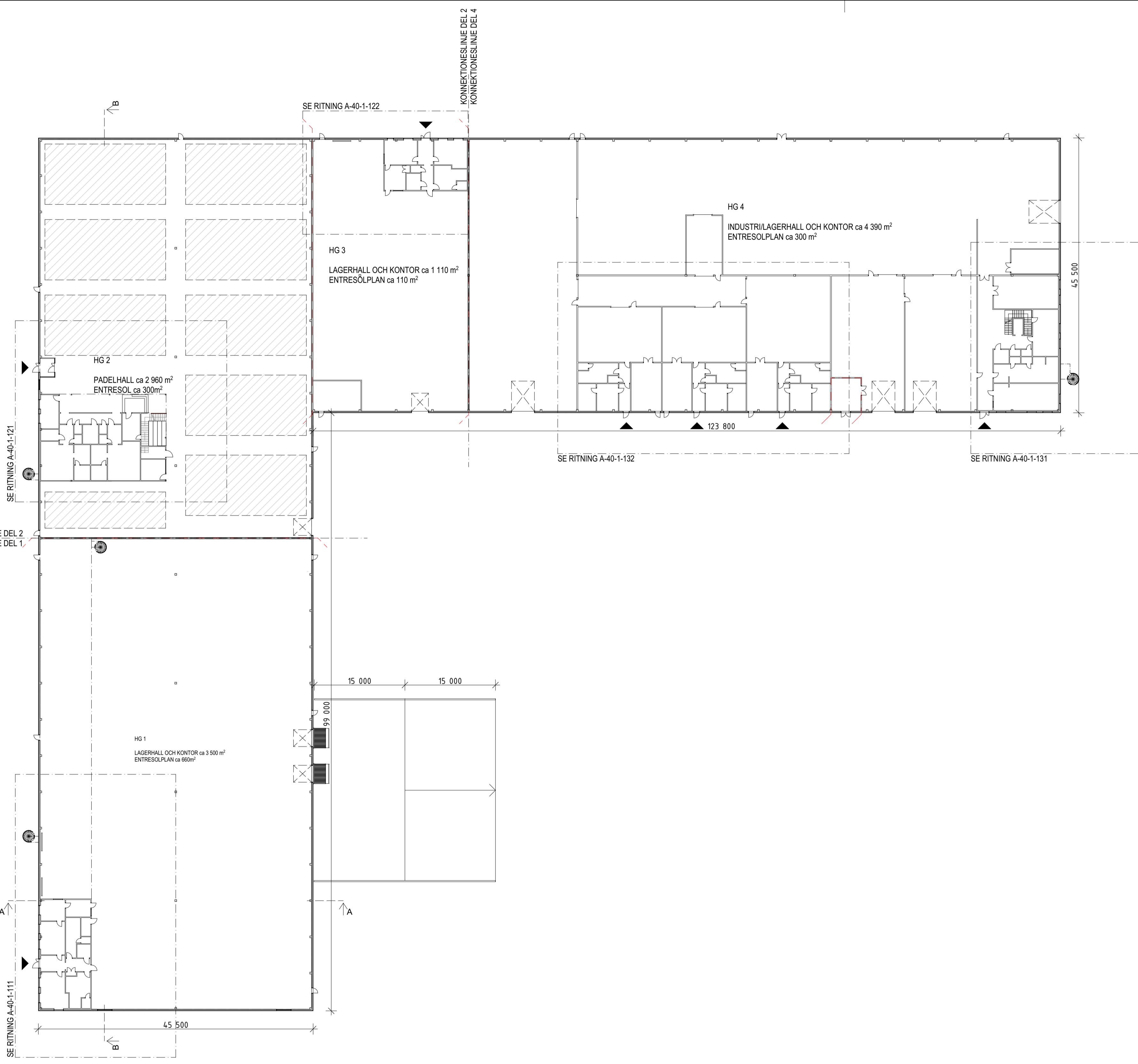

FHK 2021-05-07

A	SE PM1	STLÖ	2020-05-XX
BET	ANT	ÄNDRINGEN AVSER	SIGN

BYGGLOVSHANDLING

VAGGERYD LOGISTIKPARK
VAGGERYD



ORIENTERINGSGIFUR

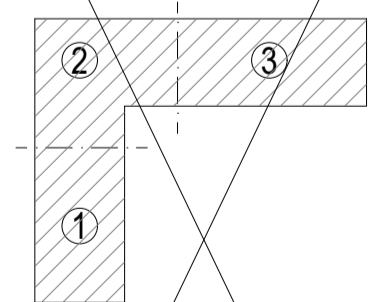

Tengbom Stora Nygatan 1 411 08 Göteborg
031-80 64 50

UPPDRAG NR 1036147	RITAD AV S Löf	HANDLÄGGARE S Löf
DATUM 2021-03-15	ANSVARIG A Drackner	

NYBYGGNAD AV LOGISTIKANLÄGGNING
STÖDSTORP 1:7
Plan 1, Översikt

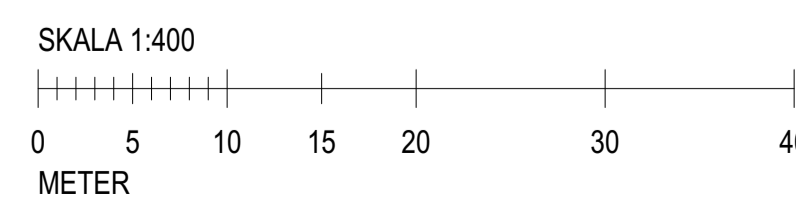

SKALA 1:400 (A1) 1:800 (A3)	NUMMER A-40-1-100	BET A
-----------------------------------	----------------------	----------

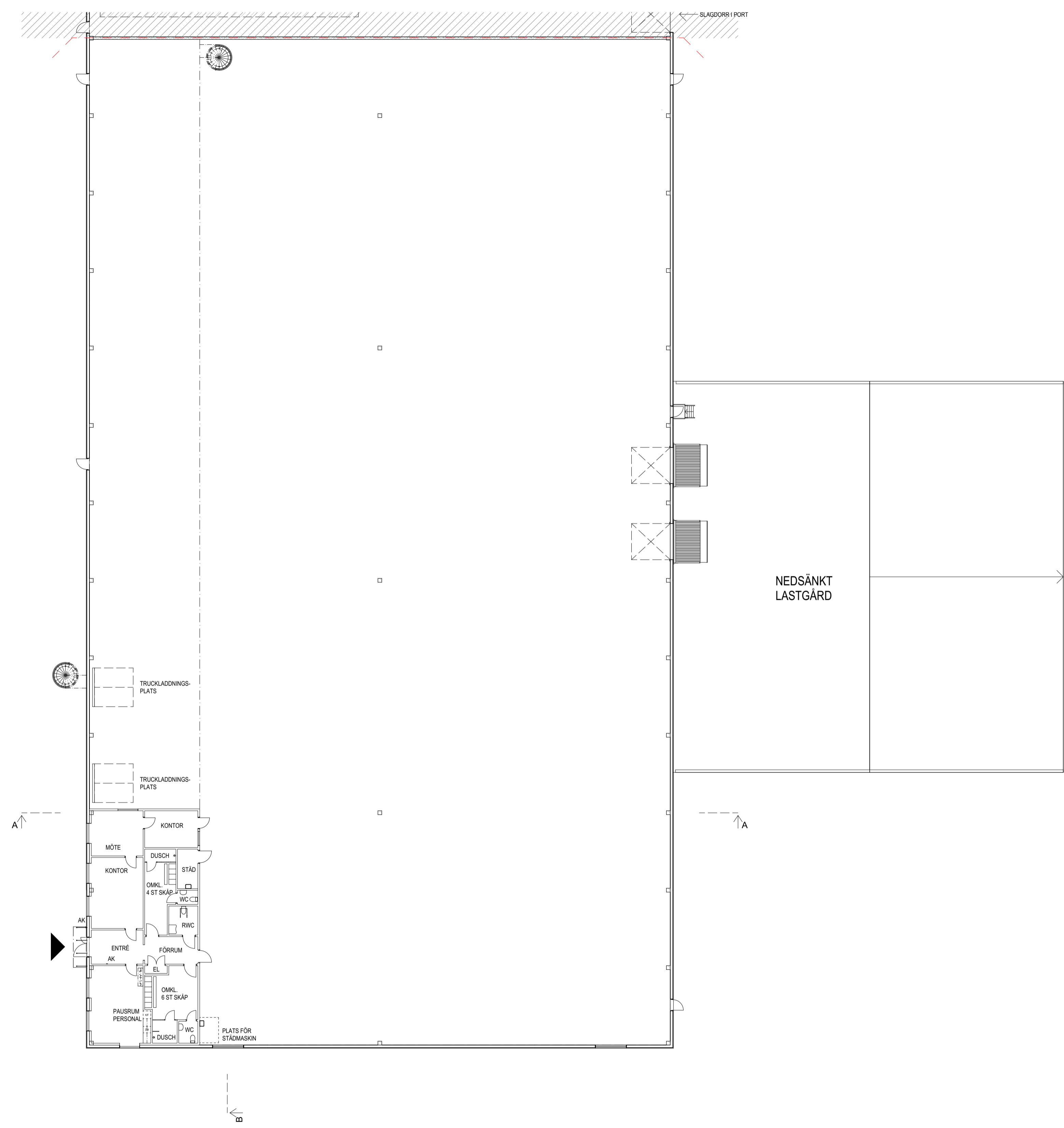

FHK 2021-05-07

BET	ANT	ÄNDRINGEN AVSER	SIGN	DATUM
		SE PM1	STLÖ	2020-05-XX

BYGGLOVSHANDLING

VAGGERYD LOGISTIKPARK
 VAGGERYD

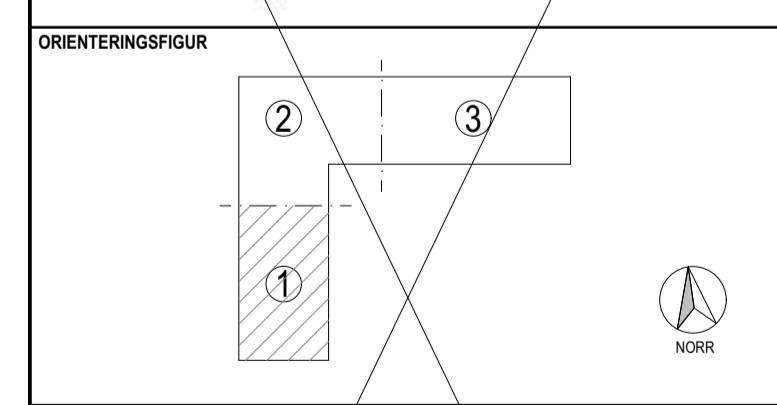

Tengbom Stora Nygatan 1 411 08 Gjöleborg
 031-80 64 50

UPPDRAG NR 1036147	RITAD AV S Löf	HANDLÄGGARE S Löf
DATUM 2021-03-15	ANSVARIG A Drackner	

NYBYGGNAD AV LOGISTIKANLÄGGNING
 STÖDSTORP 1:7
 Plan 1, Del 1

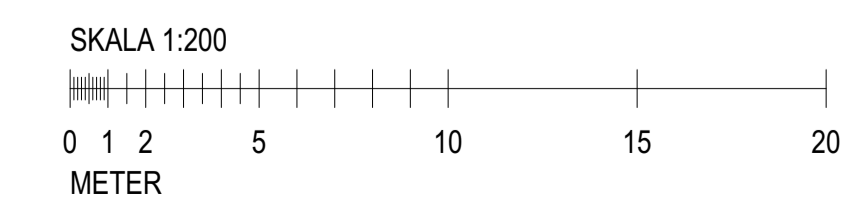

SKALA 1:200 (A1) 1:400 (A3)	NUMMER A-40-1-110	BET A
-----------------------------------	----------------------	----------

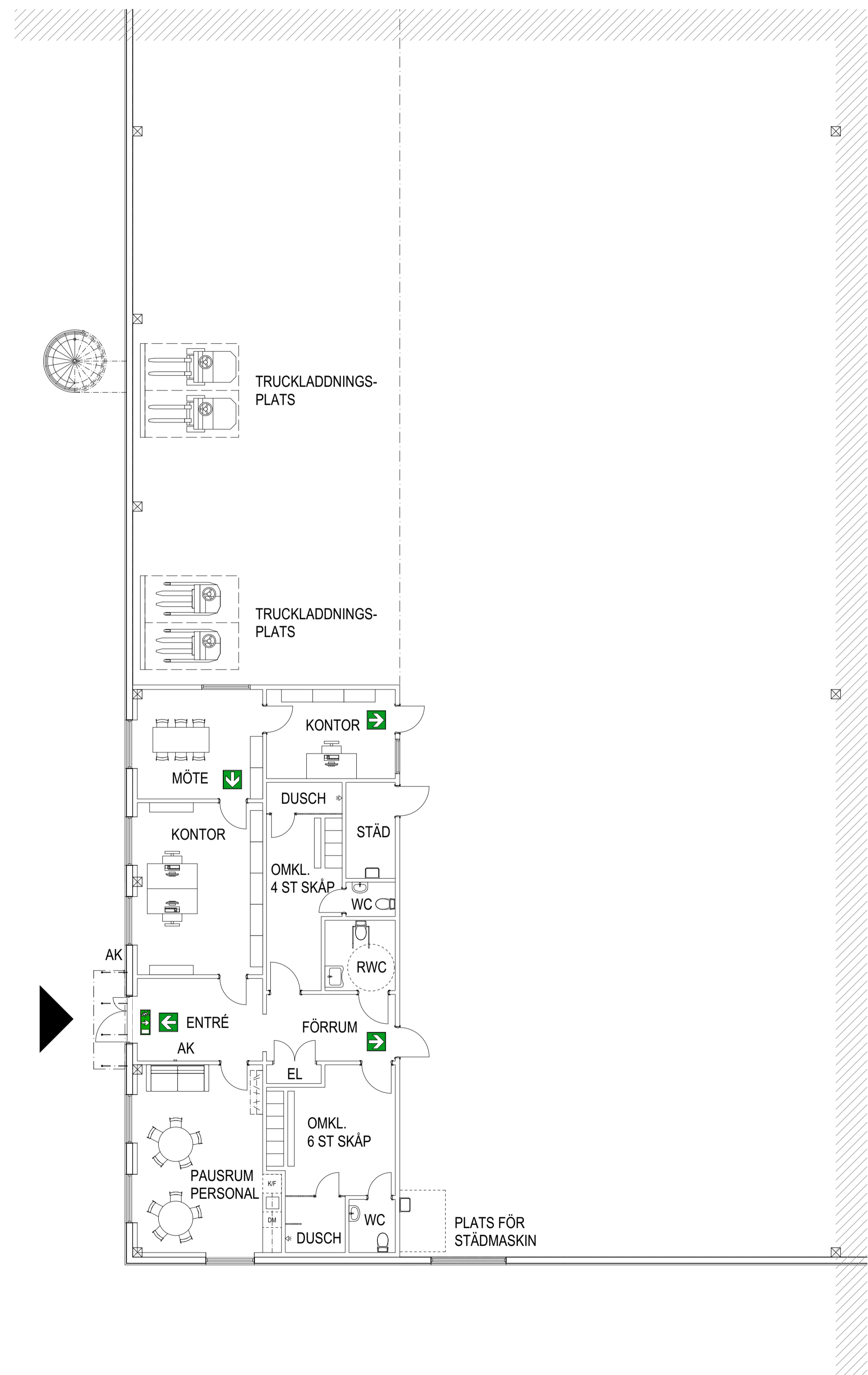

FHK 2021-05-07

A	SE PM1	STLÖ	2020-05-XX
BET	ANT	ÄNDRINGEN AVSER	SIGN

BYGGLOVSHANDLING

VAGGERYD LOGISTIKPARK
 VAGGERYD



ORIENTERINGSGIFUR

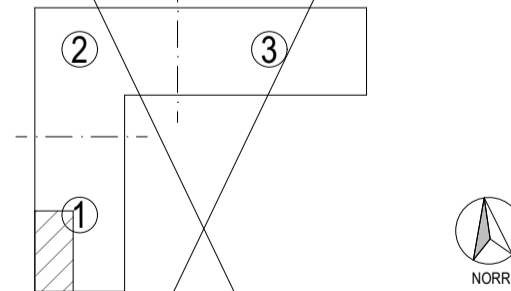

Tengbom Stora Nygatan 1 411 08 Göteborg
 031-80 64 50

UPPDRAG NR 1036147	RITAD AV S Löf	HANDLÄGGARE S Löf
DATUM 2021-03-15	ANSVARIG A Drackner	

NYBYGGNAD AV LOGISTIKANLÄGGNING
 STÖDSTORP 1:7
 Plan 1, Del 11

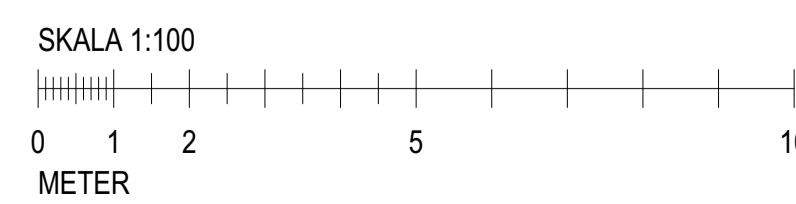

SKALA 1:100 (A1) 1:200 (A3)	NUMMER A-40-1-111	BET A
-----------------------------------	----------------------	----------

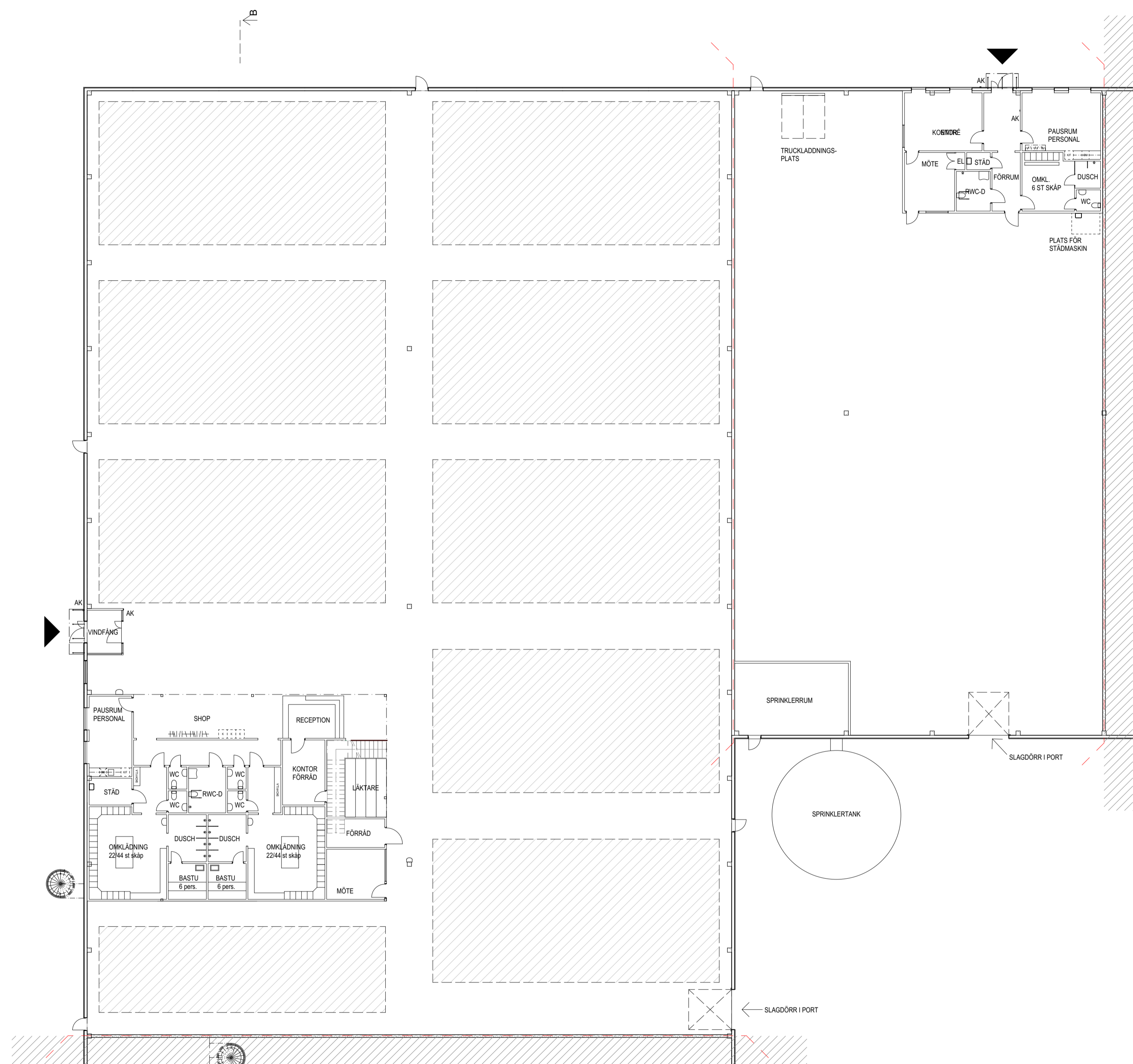

FHK 2021-05-07

A	SE PM1	STLÖ	2020-05-XX
BET	ÄNDRING AVSER	SIGN	DATUM

BYGGLOVSHANDLING

VAGGERYD LOGISTIKPARK
 VAGGERYD

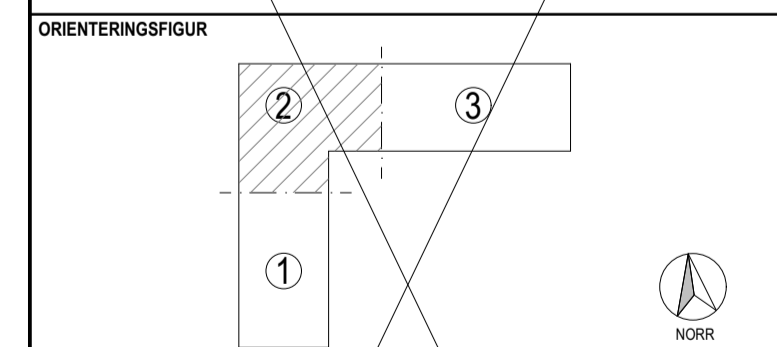

Tengbom Stora Nygatan 1 411 08 Göteborg
 031-80 64 50

UPPDRAG NR 1036147	RITAD AV S Löf	HANDLÄGGARE S Löf
DATUM 2021-03-15	ANSVARIG A Drackner	

NYBYGGNAD AV LOGISTIKANLÄGGNING
 STÖDSTORP 1:7
 Plan 1, Del 2

SKALA 1:200



SKALA 1:200 (A1) 1:400 (A3)	NUMMER A-40-1-120	BET A
-----------------------------------	----------------------	----------

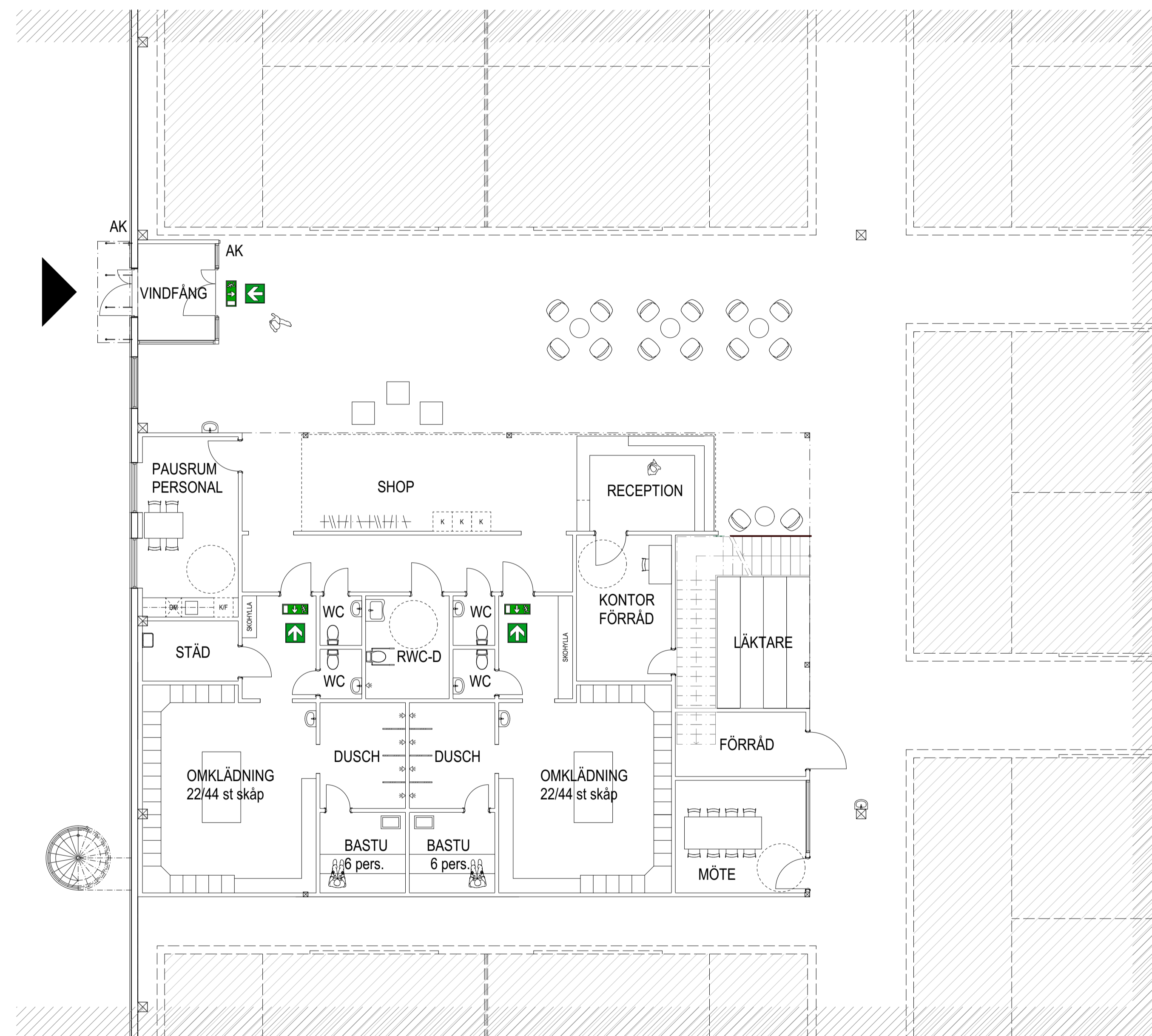

FHK 2021-05-07

BET	ANT	ÄNDRINGEN AVSER	SIGN	DATUM

BYGGLOVSHANDLING

VAGGERYD LOGISTIKPARK
 VAGGERYD



ORIENTERINGSGRUBB

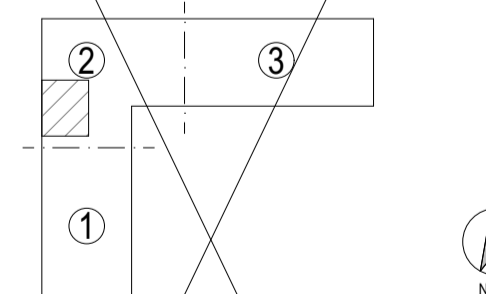

Tengbom Stora Nygatan 1 411 08 Göteborg
 031-80 64 50

UPPDRAG NR	RITAD AV	HANDLÄGGARE
1036147	S Löf	S Löf
DATUM	ÄNDRING	
2021-03-15	A Drackner	

NYBYGGNAD AV LOGISTIKANLÄGGNING
 STÖDSTORP 1:7
 Plan 1, Del 21

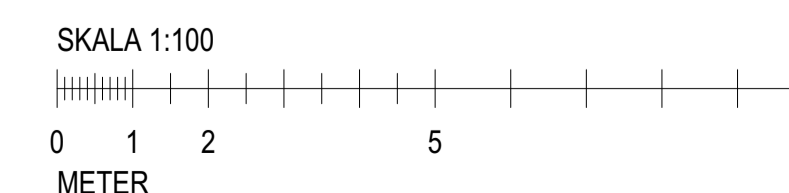

SKALA	NUMMER	BET
1:100 (A1) 1:200 (A3)	A-40-1-121	A

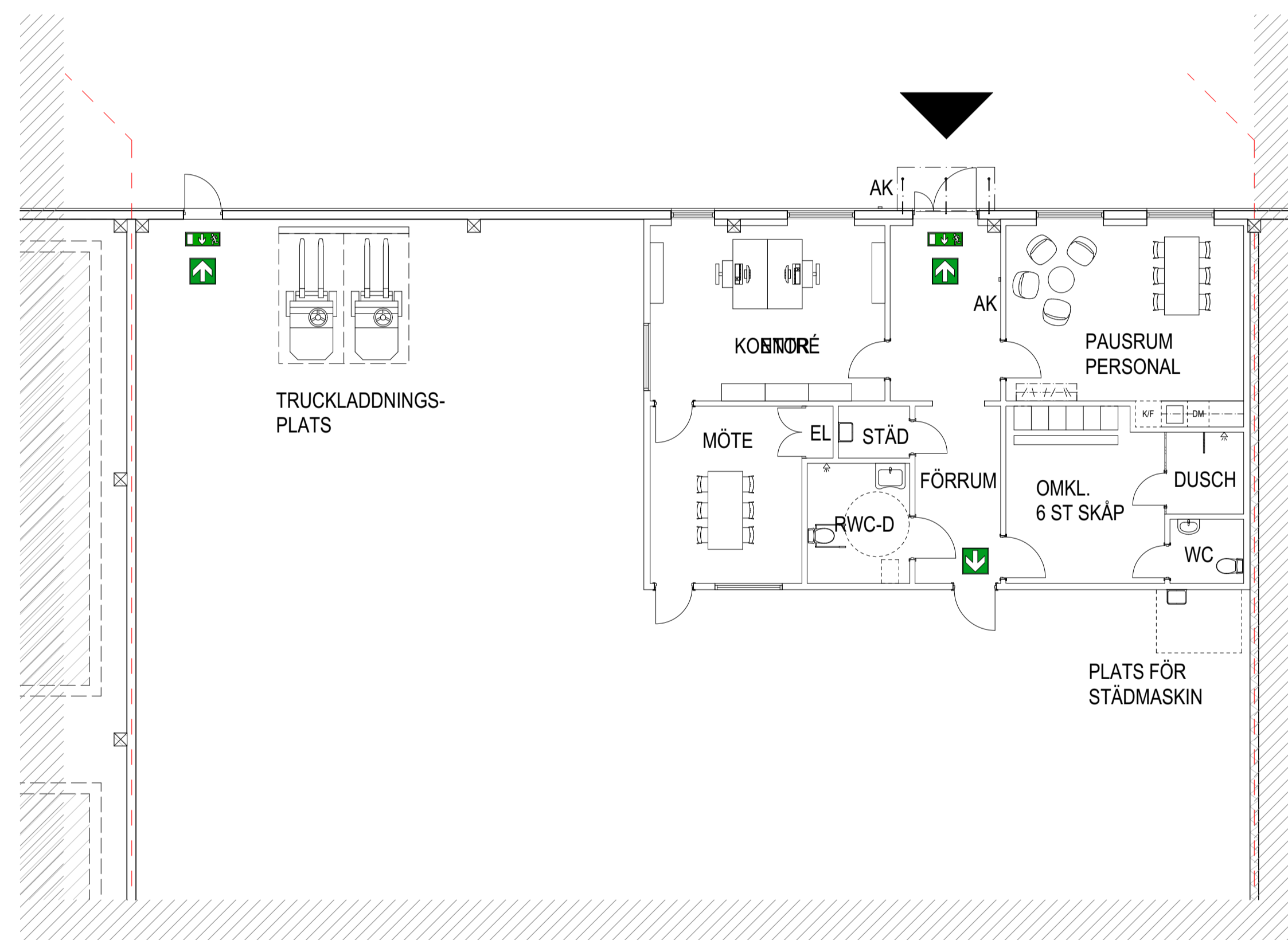

FHK 2021-05-07

BET	ANT	ÄNDRINGEN AVSER	SIGN	DATUM

BYGGLOVSHANDLING

VAGGERYD LOGISTIKPARK
 VAGGERYD



ORIENTERINGSGIFUR

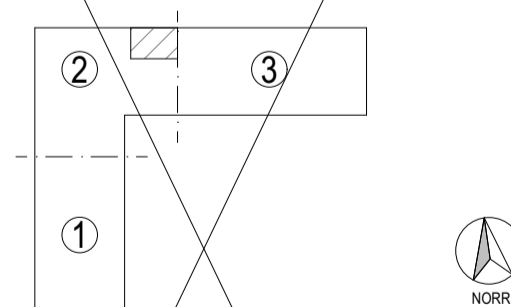

Tengbom Stora Nygatan 1 411 08 Göteborg
 031-80 64 50

UPPDRAG NR	RITAD AV	HANDLÄGGARE
1036147	S Löf	S Löf
DATUM	ANSVARIG	
2021-03-15	A Drackner	

NYBYGGNAD AV LOGISTIKANLÄGGNING
 STÖDSTORP 1:7
 Plan 1, Del 22

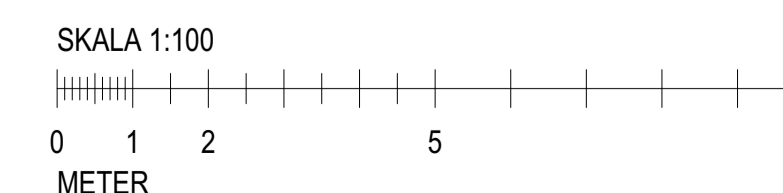

SKALA	NUMMER	BET
1:100 (A1) 1:200 (A3)	A-40-1-122	A

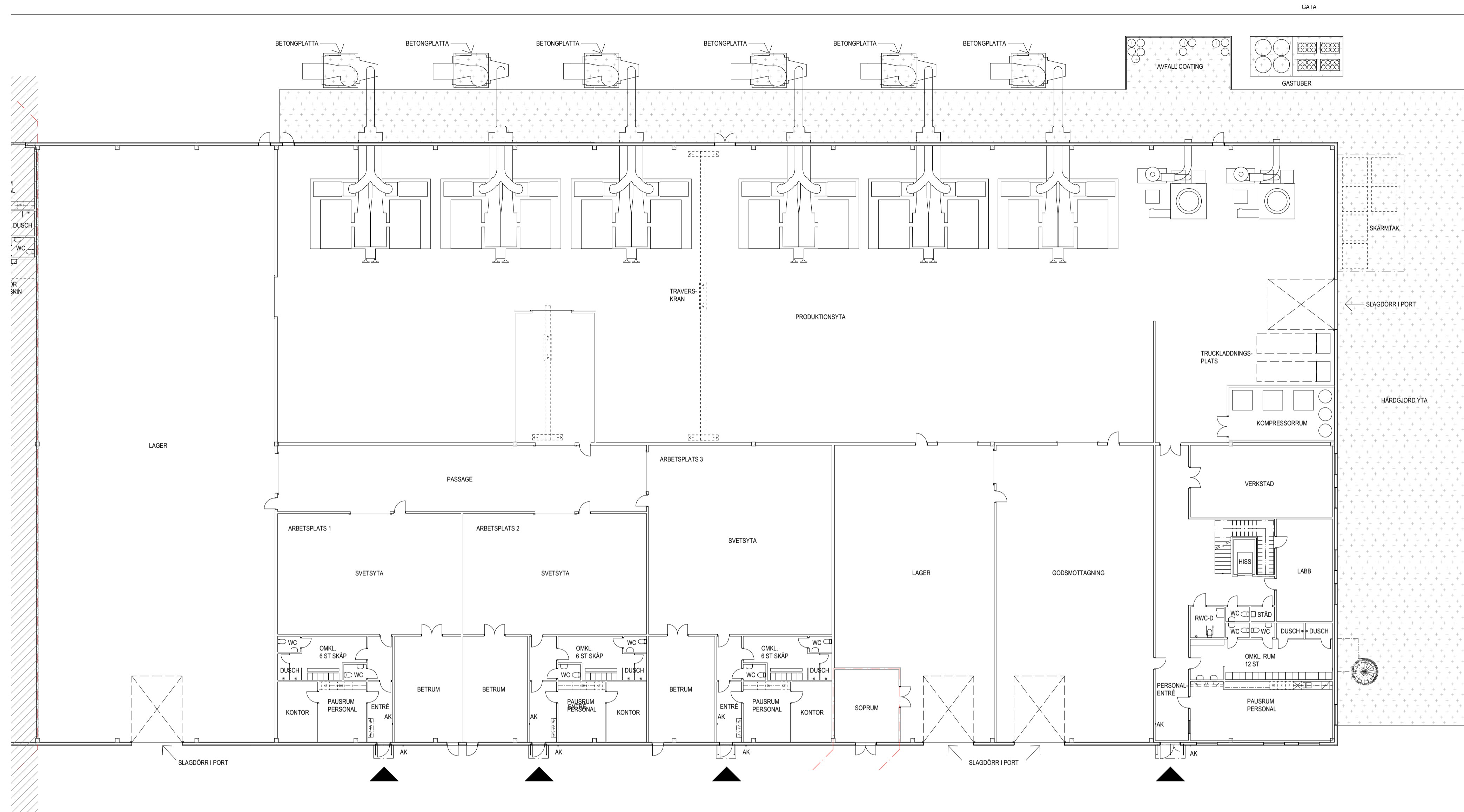

FHK 2021-05-07

A	SE PM1	STLÖ	2020-05-XX
BET	ANT	ÄNDRINGEN AVSER	SIGN DATUM

BYGGLOVSHANDLING

VAGGERYD LOGISTIKPARK
 VAGGERYD



ORIENTERINGSGRUBB

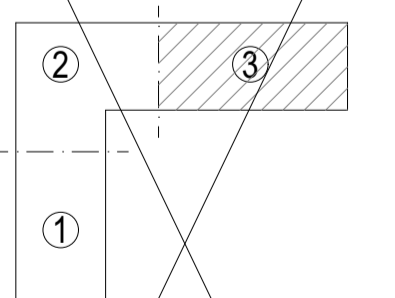

Tengbom Stora Nygatan 1 411 08 Gagnef
 031-80 64 50

UPPDRAG NR 1036147	RITAD AV S Löf	HANDLÄGGARE S Löf
DATUM 2021-03-15	ANSVARIG A Drackner	

NYBYGGNAD AV LOGISTIKANLÄGGNING
 STÖDSTORP 1:7
 Plan 1, Del 3

SKALA 1:200

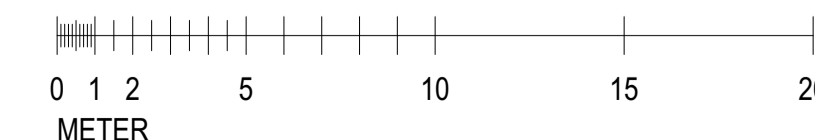

SKALA 1:200 (A1) 1:400 (A3)	NUMMER A-40-1-130	BET A
-----------------------------------	----------------------	----------

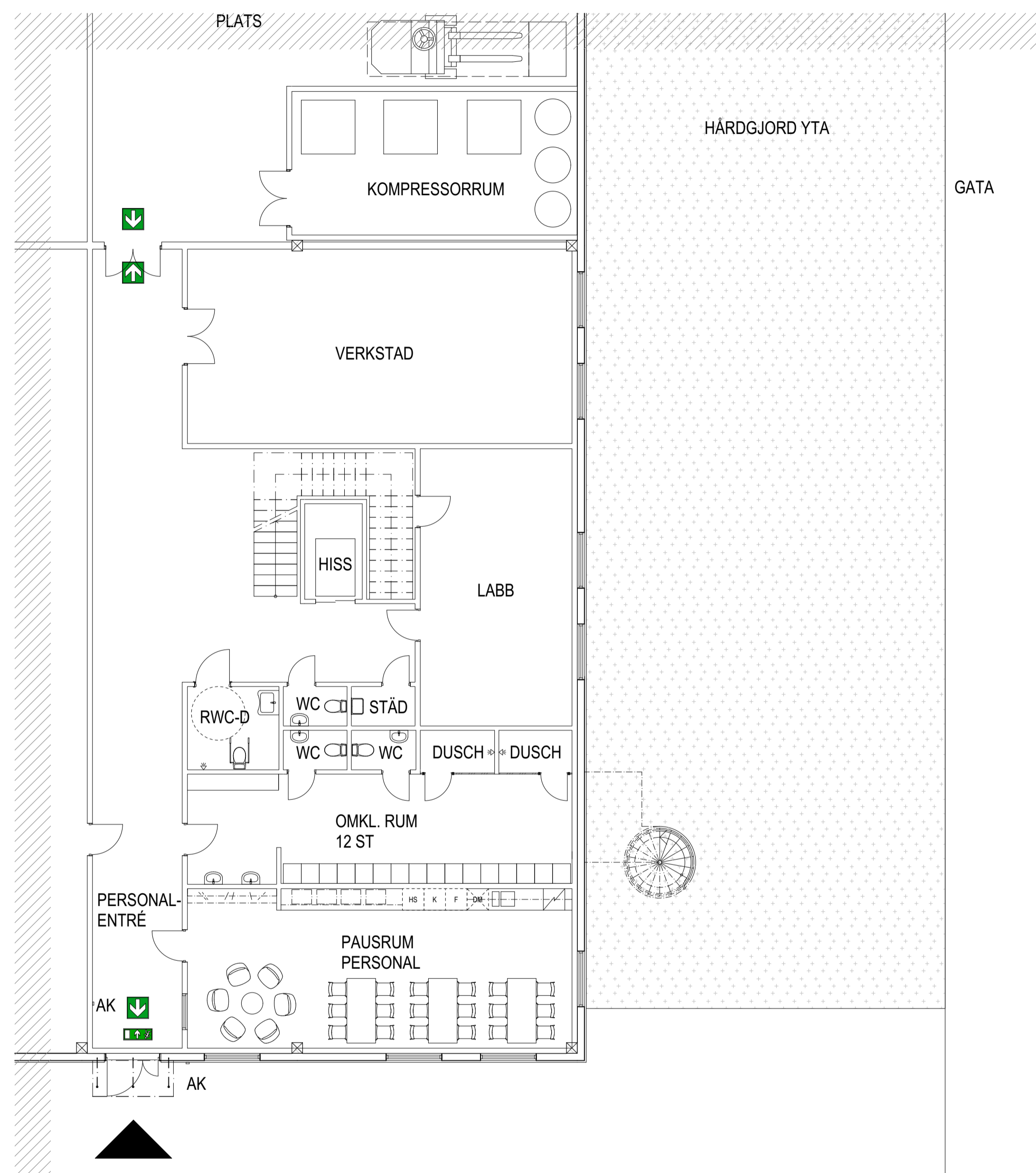

FHK 2021-05-07

BET	ANT	ÄNDRINGEN AVSER	SIGN	DATUM

BYGGLOVSHANDLING

VAGGERYD LOGISTIKPARK
 VAGGERYD



ORIENTERINGSGIFUR

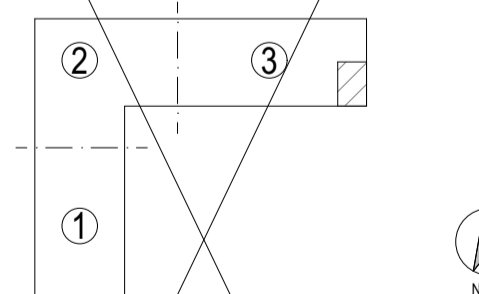

Tengbom Stora Nygatan 1 411 08 Göteborg
 031-80 64 50

UPPDRAG NR	RITAD AV	HANDLÄGGARE
1036147	S Löf	S Löf
DATUM	ANSVARIG	
2021-03-15	A Drackner	

NYBYGGNAD AV LOGISTIKANLÄGGNING
 STÖDSTORP 1:7
 Plan 1, Del 31

SKALA 1:100



SKALA	NUMMER	BET
1:100 (A1) 1:200 (A3)	A-40-1-131	A

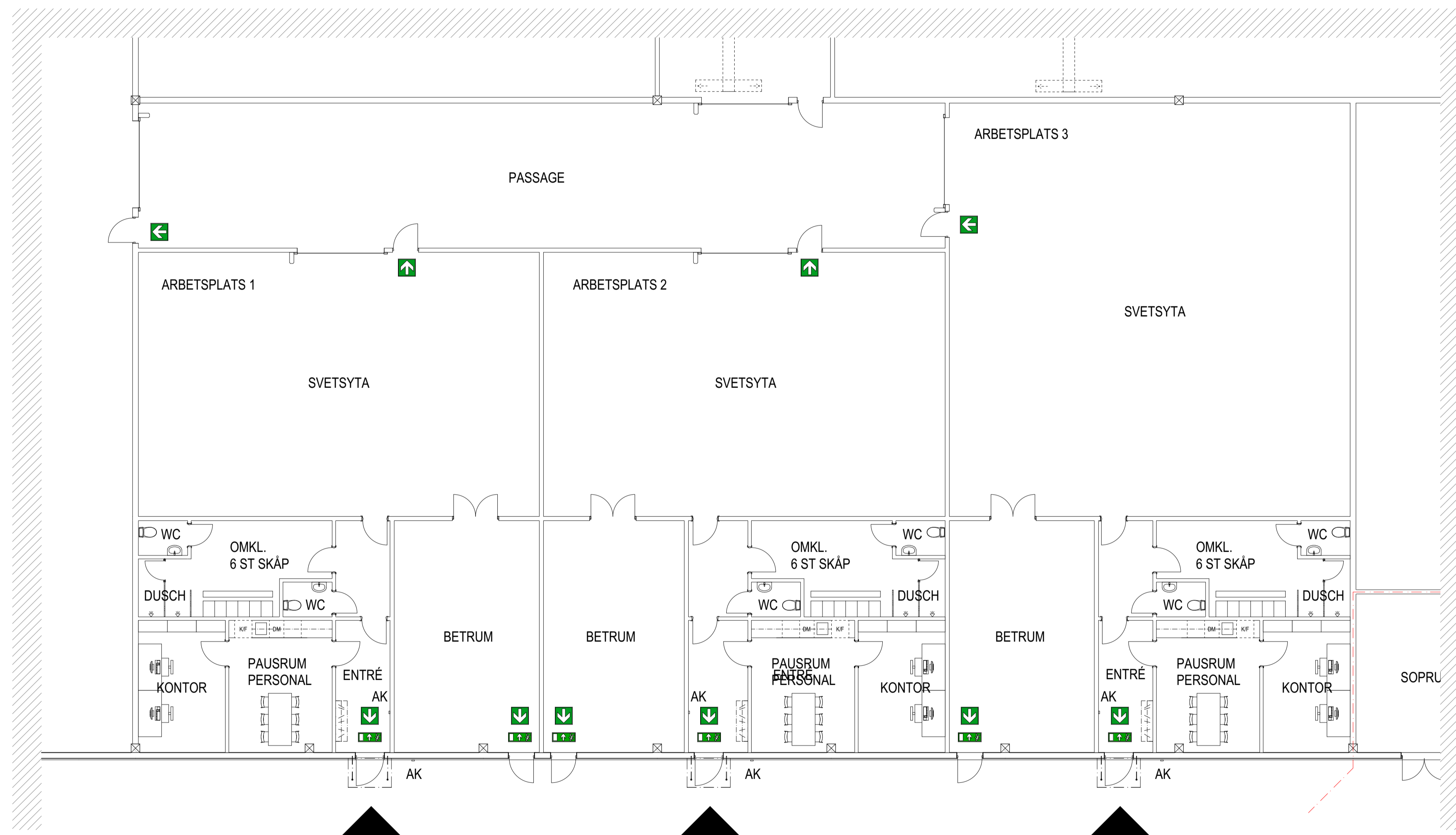

FHK 2021-05-07

BET	ANT	ÄNDRINGEN AVSER	SIGN	DATUM

BYGGLOVSHANDLING

VAGGERYD LOGISTIKPARK
 VAGGERYD



ORIENTERINGSGRUBB

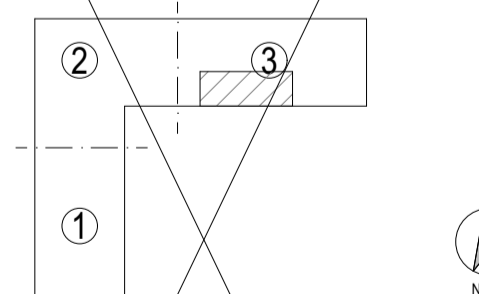

Tengbom Stora Nygatan 1 411 08 Gårdebo
 031-80 64 50

UPPDRAG NR 1036147	RITAD AV S Löf	HANDLÄGGARE S Löf
DATUM 2021-03-15	ANSVARIG A Drackner	

NYBYGGNAD AV LOGISTIKANLÄGGNING
 STÖDSTORP 1:7
 Plan 1, Del 32

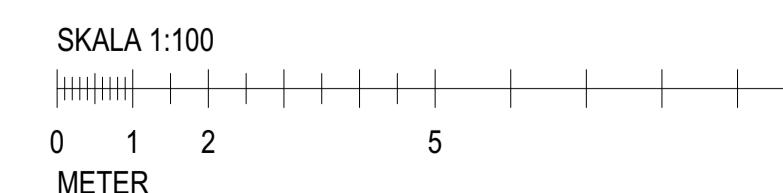

SKALA 1:100 (A1) 1:200 (A3)	NUMMER A-40-1-132	BET
-----------------------------------	----------------------	-----

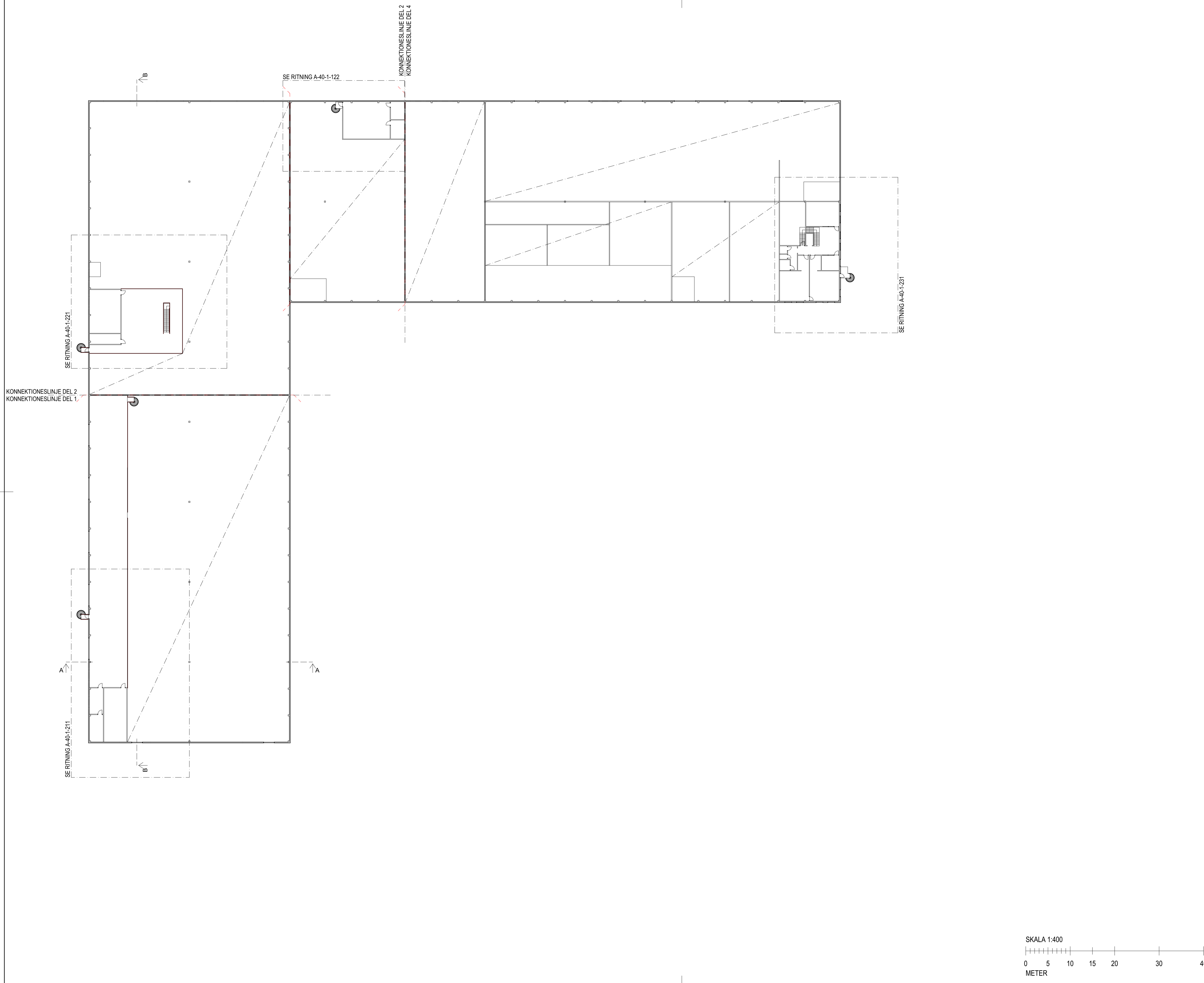

FHK 2021-05-07

A	SE PM1	STLÖ	2020-05-XX
BET	ANT	ÄNDRINGEN AVSER	SIGN

BYGGLOVSHANDLING

VAGGERYD LOGISTIKPARK
 VAGGERYD



ORIENTERINGSGIFUR

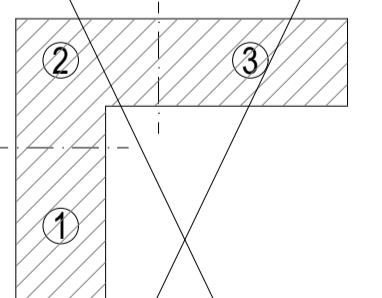

Tengbom Stora Nygatan 1 411 08 Gårdebo
 031-80 64 50

UPPDRAG NR 1036147	RITAD AV S Löf	HANDLÄGGARE S Löf
DATUM 2021-03-15	ÄNDRING A Drackner	

NYBYGGNAD AV LOGISTIKANLÄGGNING
 STÖDSTORP 1:7
 Plan 2, Översikt

SKALA 1:400

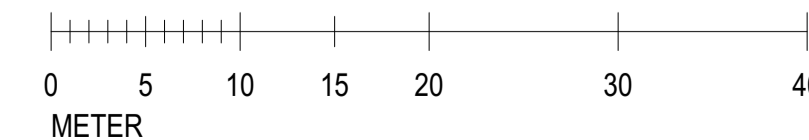

SKALA 1:400 (A1) 1:800 (A3)	NUMMER A-40-1-200	BET A
-----------------------------------	----------------------	----------

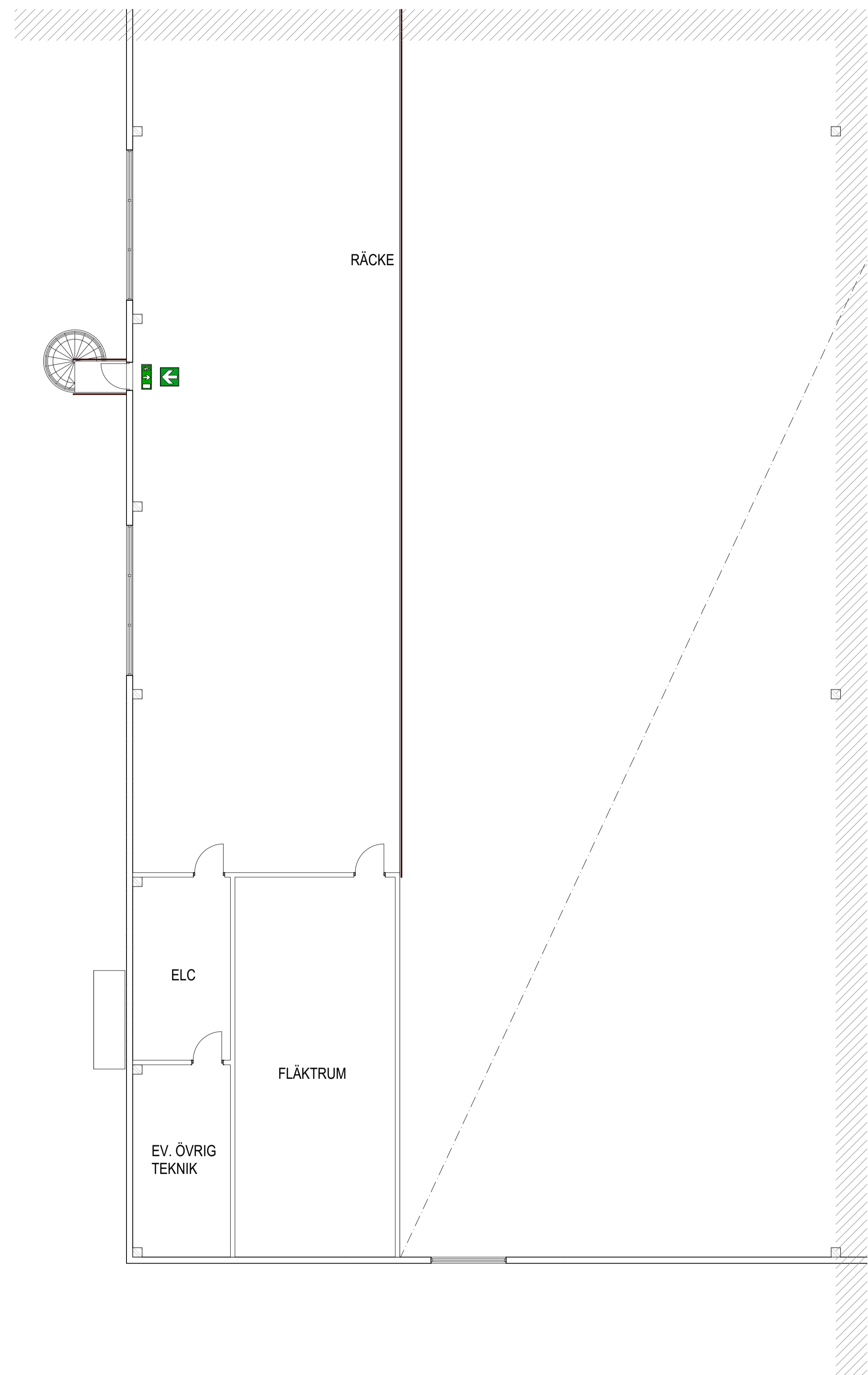

FHK 2021-05-07

BET	ANT	ÄNDRINGEN AVSER	SIGN	DATUM

BYGGLOVSHANDLING

VAGGERYD LOGISTIKPARK
 VAGGERYD



ORIENTERINGSGIFUR

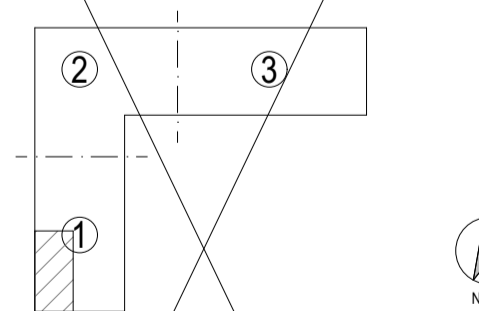

Tengbom Stora Nygatan 1 411 08 Göteborg
 031-80 64 50

UPPDRAG NR	RITAD AV	HANDLÄGGARE
1036147	S Löf	S Löf
DATUM	ÄNDRING	
2021-03-15	A Drackner	

NYBYGGNAD AV LOGISTIKANLÄGGNING
 STÖDSTORP 1:7
 Plan 2, Del 11

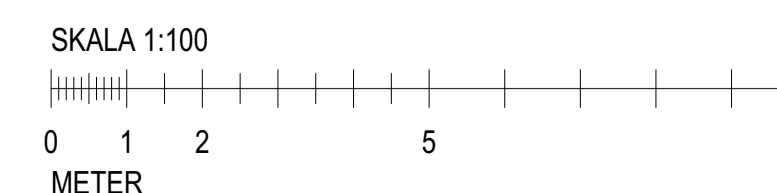

SKALA	NUMMER	BET
1:100 (A1) 1:200 (A3)	A-40-1-211	A

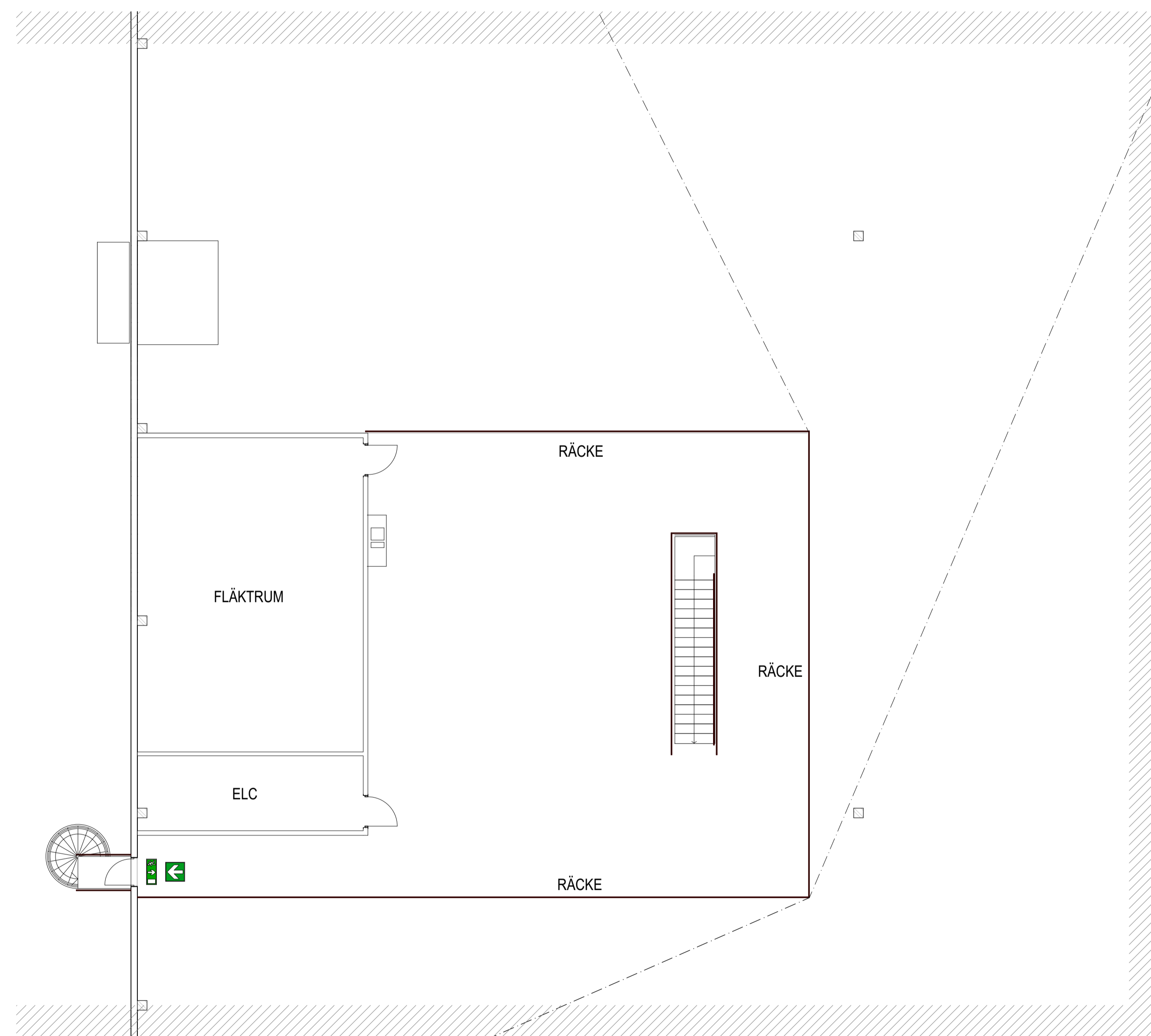

FHK 2021-05-07

A	SE PM1	STLÖ	2020-05-XX
BET	ANT	ÄNDRINGEN AVSER	SIGN

BYGGLOVSHANDLING

VAGGERYD LOGISTIKPARK
 VAGGERYD



ORIENTERINGSGIFUR

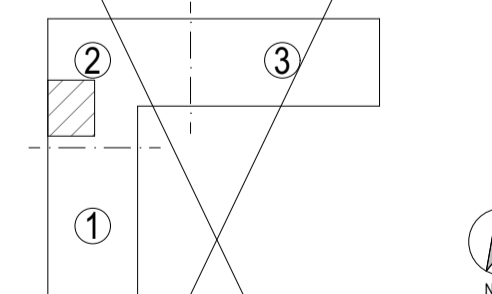

Tengbom Stora Nygatan 1 411 08 Göteborg
 031-80 64 50

UPPDRAG NR 1036147	RITAD AV S Löf	HANDLÄGGARE S Löf
DATUM 2021-03-15	ANSVARIG A Drackner	

NYBYGGNAD AV LOGISTIKANLÄGGNING
 STÖDSTORP 1:7
 Plan 2, Del 21

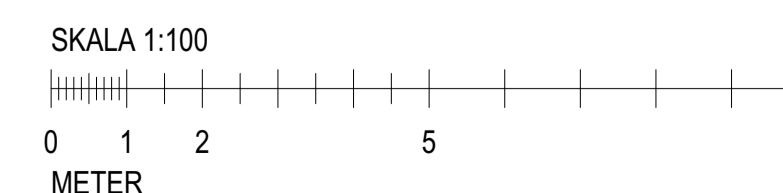

SKALA 1:100 (A1) 1:200 (A3)	NUMMER A-40-1-221	BET A
-----------------------------------	----------------------	----------

FÖRKLARINGAR / FÖRESKRIFTER
 Se ritning A-40-1-100

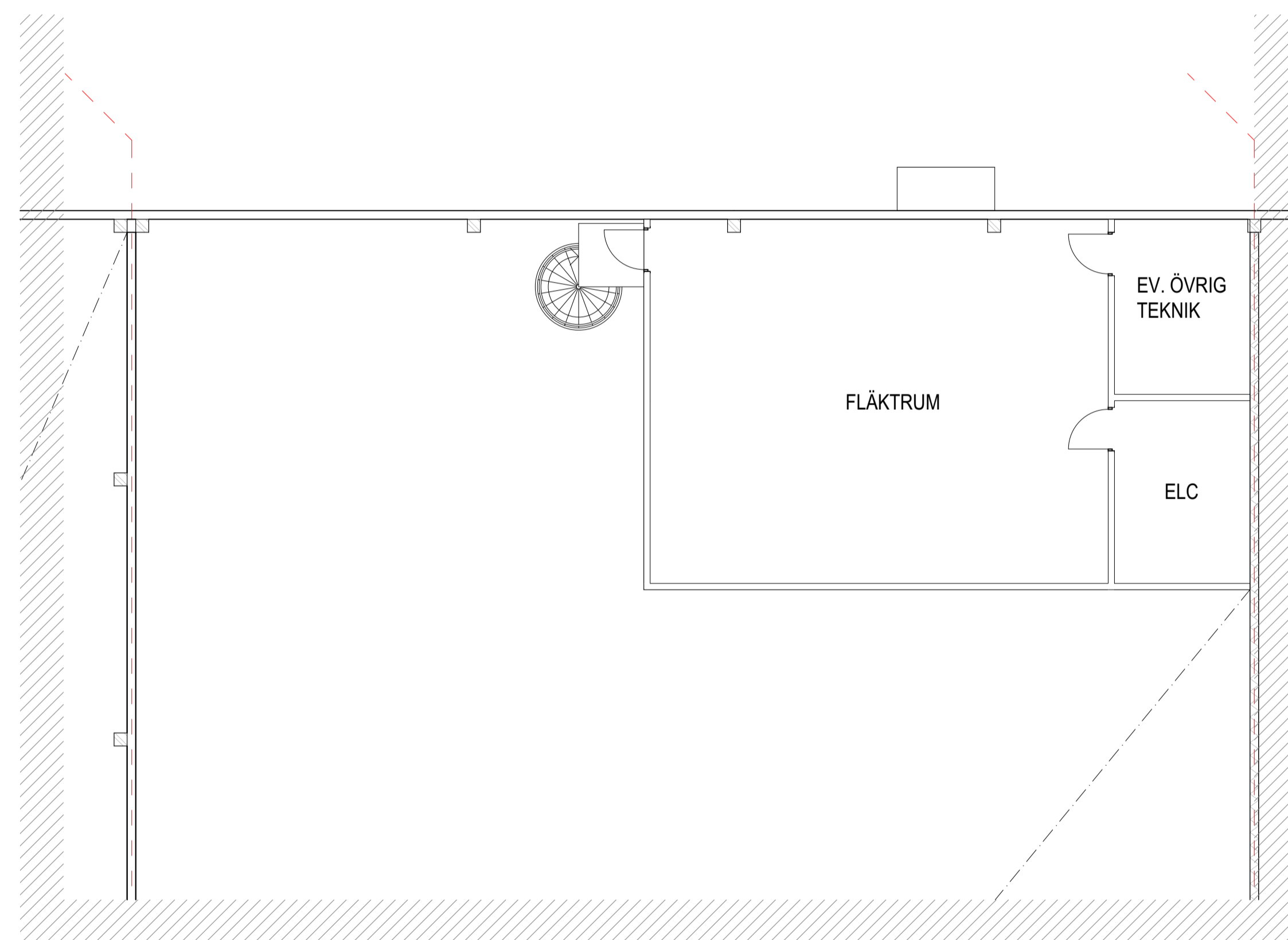

FHK 2021-05-07

A		SE PM1	STLÖ	2020-05-XX
BET	ANT	ÄNDRINGEN AVSER	SIGN	DATUM

BYGGLOVSHANDLING

VAGGERYD LOGISTIKPARK
 VAGGERYD



ORIENTERINGSGIFUR

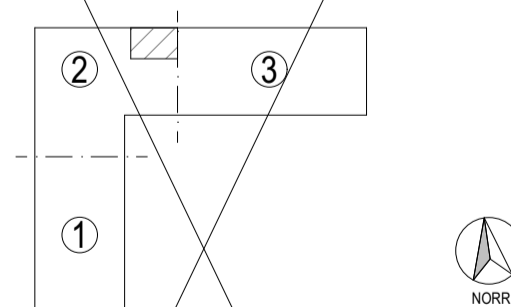

Tengbom Stora Nygatan 1 411 08 Göteborg
 031-80 64 50

UPPDRAG NR 1036147	RITAD AV S Löf	HANDLÄGGARE S Löf
DATUM 2021-03-15	ÄNDRING A Drackner	

NYBYGGNAD AV LOGISTIKANLÄGGNING
 STÖDSTORP 1:7
 Plan 2, Del 22

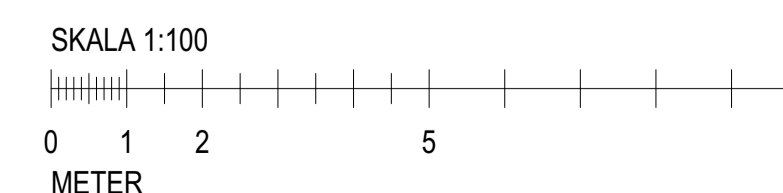

SKALA 1:100 (A1) 1:200 (A3)	NUMMER A-40-1-222	BET A
-----------------------------------	----------------------	----------

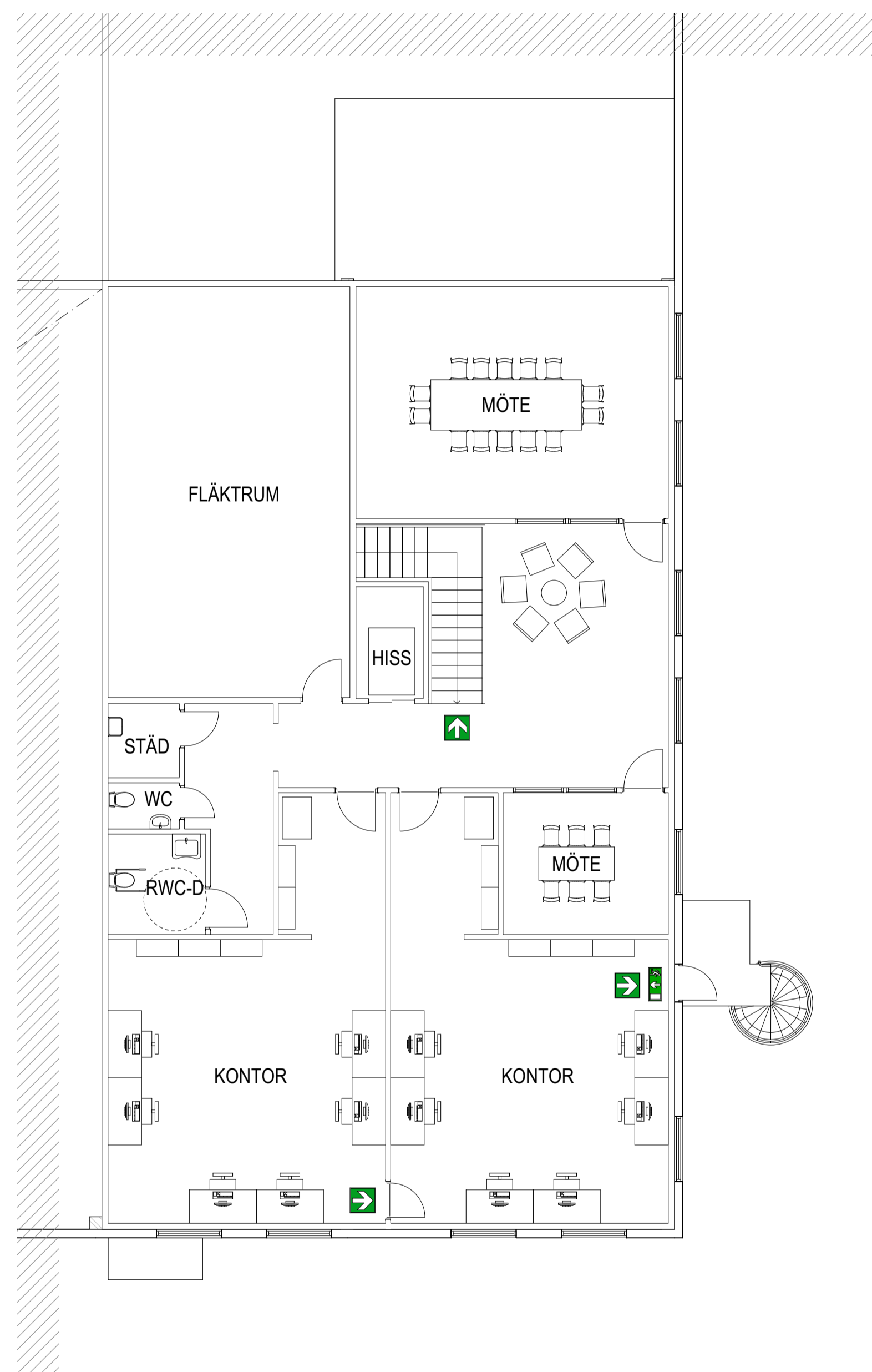

FHK 2021-05-07

A	SE PM1	STLÖ	2020-05-XX
BET	ANT	ÄNDRINGEN AVSER	SIGN

BYGGLOVSHANDLING

VAGGERYD LOGISTIKPARK
 VAGGERYD

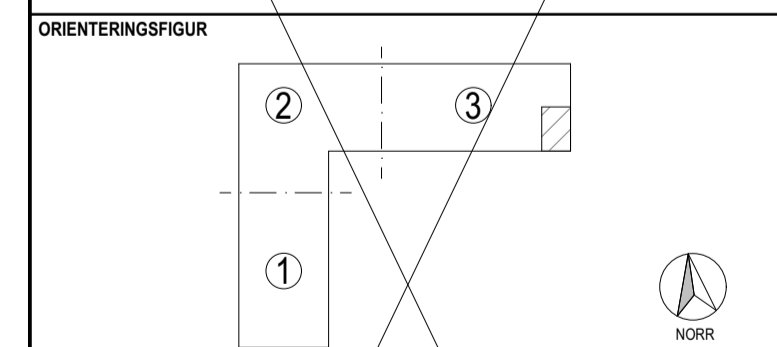

Tengbom Stora Nygatan 1 411 08 Göteborg
 031-80 64 50

UPPDRAG NR 1036147	RITAD AV S Löf	HANDLÄGGARE S Löf
DATUM 2021-03-15	ANSVARIG A Drackner	

NYBYGGNAD AV LOGISTIKANLÄGGNING
 STÖDSTORP 1:7
 Plan 2, Del 31

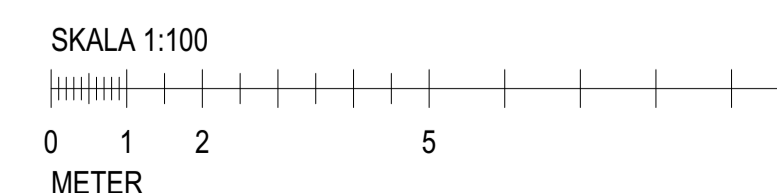

SKALA 1:100 (A1) 1:200 (A3)	NUMMER A-40-1-231	BET A
-----------------------------------	----------------------	----------